

# YAKIMA

## OWNER'S MANUAL

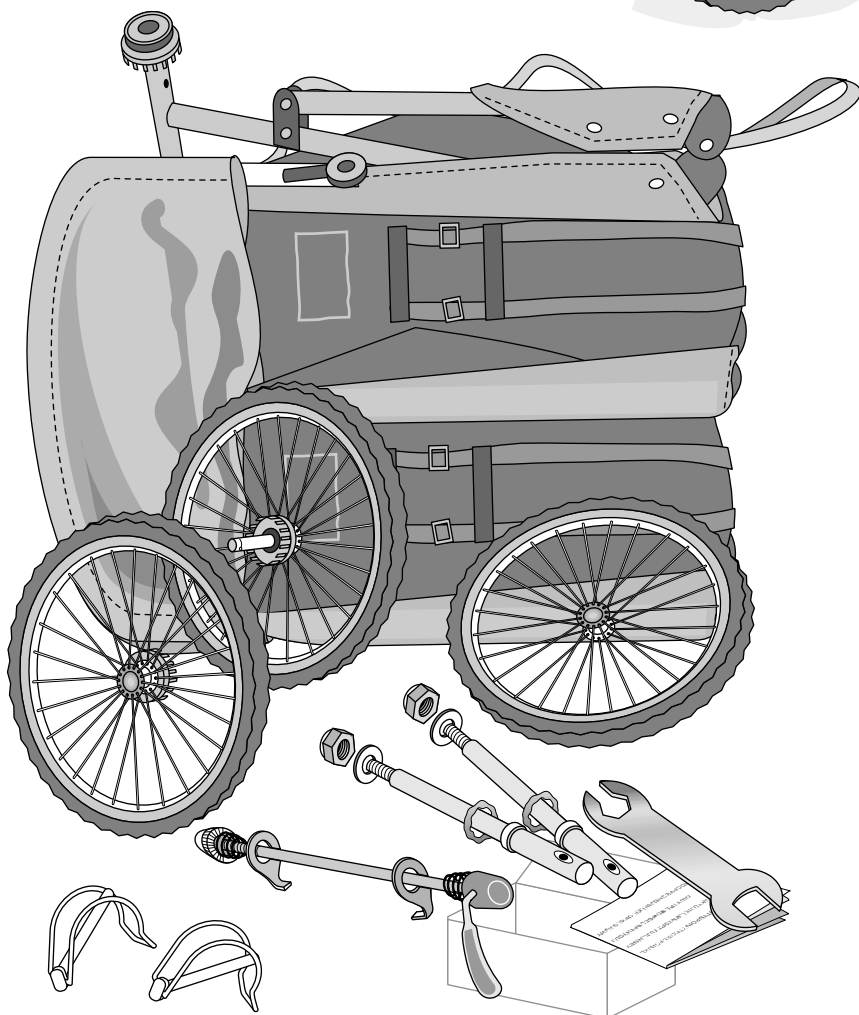

Read and understand these directions prior to operation.

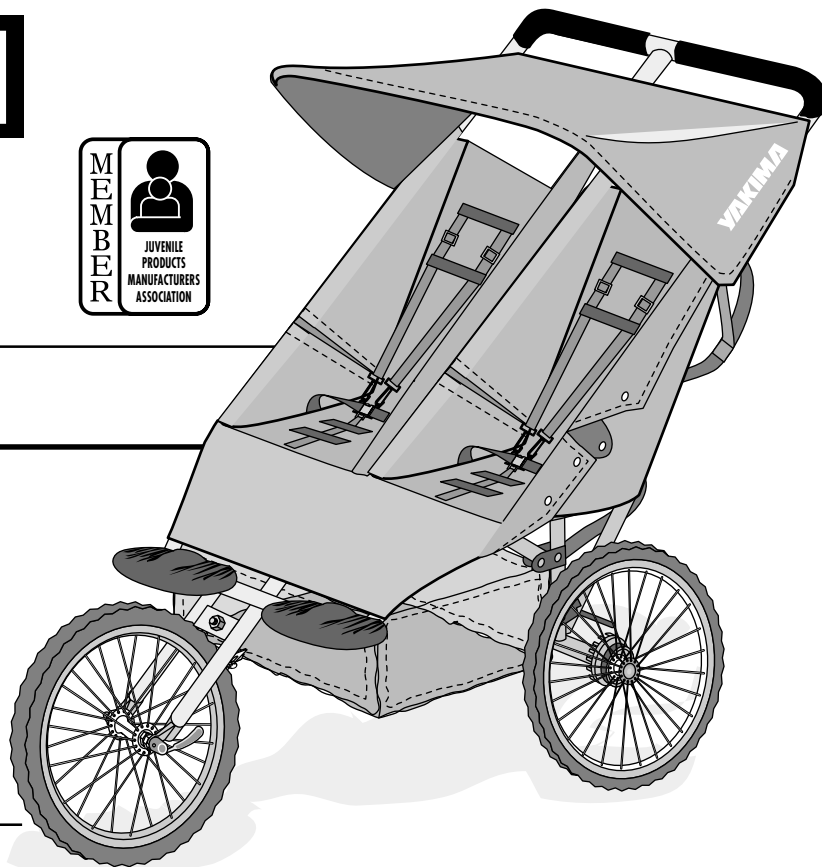

### INSIDE THIS BOOK...

Introduction .....	page 2
Before You Begin .....	3
Jogger Responsibilities .....	4
Passenger Safety .....	5
Load Limits .....	6
Tire Pressure .....	6
Safety Warnings .....	7
<b>Assembly &amp; Installation</b>	
Unfold the Stroller .....	8
Wheel Installation .....	9-10
Brakes .....	11
Child Positioning .....	12
Straps .....	12-13
<b>Passenger Qualifications .....</b>	<b>12</b>
<b>CHECKLIST (Before You Jog) .....</b>	<b>14</b>
<b>Folding the Stroller .....</b>	<b>15</b>
<b>Maintenance .....</b>	<b>16</b>

## IMPORTANT WARNING!

**BEFORE USING THIS YAKIMA JOGGING STROLLER, READ THIS MANUAL IN ITS ENTIRETY SINCE IT CONTAINS INSTRUCTIONS PERTAINING TO OPERATION, ASSEMBLY AND SAFETY. FAILURE TO ADHERE TO THE INFORMATION, IN THE OWNERS' MANUAL, COULD RESULT IN AN ACCIDENT CAUSING SERIOUS BODILY INJURY OR DEATH. YOU ARE RESPONSIBLE FOR THE PROPER USE OF THIS YAKIMA JOGGING STROLLER. THIS INCLUDES PROPER ASSEMBLY AS WELL AS THE PROPER USE OF THE SAFETY RESTRAINT SYSTEM TO SECURE YOUR CHILD. PRIOR TO EACH USE, INSPECTIONS SHOULD BE PERFORMED TO CHECK FOR ANY NEEDED ADJUSTMENTS, WEAR OR DAMAGE. DISCONTINUE USE IMMEDIATELY IF THE UNIT SHOULD BECOME DAMAGED OR MALFUNCTIONS. IF YOU DO NOT UNDERSTAND ALL THE INSTRUCTIONS PERTAINING TO THE ASSEMBLY OF THE STROLLER, YOU SHOULD HAVE THE STROLLER ASSEMBLED BY A PROFESSIONAL BIKE SHOP OR QUALIFIED TECHNICIAN.**

---

# **YAKIMA** **BUG** Jogging Stroller

## *Congratulations & Thanks*

for choosing a Yakima stroller to safely transport your child.

---

This stroller will enable you to enjoy the quality standards and dedication to good times that Yakima has offered outdoor enthusiasts for over two decades. We take our commitment to safety seriously and ask that you take the time to read this important owner's manual.

No one is better equipped to properly care for your child than you are. The safety guidelines found within this booklet, combined with your own good judgement as a parent, should put you well on your way to a safe and rewarding recreational experience. We wouldn't want it any other way.

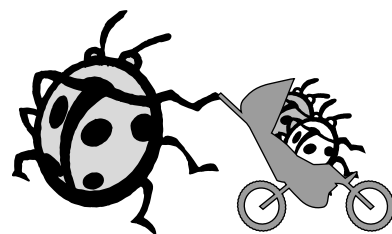

## BEFORE YOU BEGIN:

**Read all of this booklet before assembling and operating your new stroller!**



*Have the children play alone while you enjoy a cup of tea and focus on this important information regarding your new stroller.*



### WARNING:

**Failure to read and follow the instructions contained in these pages may result in accidents and serious injury or death.**



## Jogging with a stroller is *different!*

### USING A STROLLER

If you haven't yet had this experience, take time to get the feel of a stroller before attempting to run while also transporting a child.

### JOGGING WITH A STROLLER

If you've never run with a stroller out in front of you, familiarize yourself with how it feels. Go for a practice run in a relatively calm, traffic free area, before a passenger is ever on board. Next, load up to 45 lbs. of weight into your stroller and take another practice lap to gauge what it may feel like to run with a passenger.

You will probably have to alter your jogging style to compensate for increased length and weight created by the stroller. Get a feel for how you might perform under different circumstances. This way, you will be well prepared to react in the safest most responsible manner.

## STAY ON LEVEL GROUND —AND OFF THE SKATES!

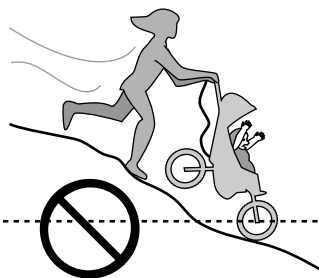

- **NEVER** use on steep grades, inclines or hills.
- **NEVER** use jogging stroller while roller-skating, roller-blading or biking.
- **NEVER** allow the jogging stroller to be attached to— or pulled by dogs, bicycles, automobiles, snowmobiles or other machines.
- This stroller is not equipped for use after dark, and we do not recommend use of stroller after dark.
- Discontinue use of your stroller if it malfunctions or becomes damaged.

## — IT ALL BEGINS WITH THE JOGGER —

**USE GOOD JUDGEMENT:** *Jogging with a stroller requires physical strength and sound mental judgement.*

### **JOGGER'S RESPONSIBILITIES:**

- **ALWAYS** use seat harness to avoid serious injury to child. An unrestrained child is at risk of falling or sliding out of stroller.
- **ALWAYS** keep the safety strap attached to your wrist while using the stroller.
- **NEVER** allow a child to stand in the stroller.
- **ALWAYS** set the rear brakes when loading or unloading.
- **NEVER** leave a child unattended.
- **DO NOT** wear headphones while jogging with a stroller.
- **AVOID** a busy road or highway that is unsafe for a child. Run defensively and don't assume that you will be seen or given the right of way by autos or bicycles.
- **DO NOT** allow a child or adolescent to push the stroller. They do not have the strength or good judgement to safely do so.

### •• **AVOID TIPPING OVER** ••

*Just like everything else affected by the pull of gravity, your stroller can and will tip over in certain circumstances. Here are some tips to reduce that risk:*

- Monitor children closely so they do not stand up or lean out of the stroller as this may cause the stroller to tip over.
- Monitor children to insure that all body parts, clothes, toys and any other objects are kept away from the wheels and other moving parts.
- Slow down when turning and avoid sudden swerves or directional changes.
- Do not strap bags or packages to handle; it affects the balance and stability of the stroller and can cause it to tip over backwards.
- Always cross tracks, curb cutouts and grooved road surfaces at a 90-degree angle. Narrow angles when crossing such obstacles could cause tip over resulting in accident and injury.
- Not intended for off-road travel. Run on paved surfaces only. Avoid curb hopping, potholes and any other road obstructions as you run with your stroller.



**WARNING:**  
**Bouncing or rocking by passengers can cause serious injury or death.**



### **NIGHT RUNS:**

*Avoid jogging at night by planning your run in the daylight hours.*

# PASSENGER SAFETY

## NEVER LEAVE YOUR CHILD UNATTENDED IN THE STROLLER!

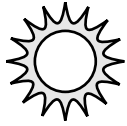

### Avoid direct sunlight on the passengers.

Heat can build quickly in intensity and cause serious injury. You can open or close the canopy to help cool or warm your child but always be aware of the wind chill factor and the dangers posed by UV radiation.



### Check your children frequently

Make sure the child is safe and comfortable. Remember that the environment inside the stroller is not the same as it is for you. Be aware of the wind chill factor on small children.



### Dress your passengers

Use the layering system and bring some extra clothing, a hat, and a blanket just in case. Never leave your child exposed to the elements.

### Everyone Needs Water

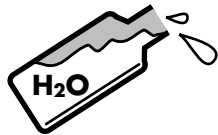

It is important to keep yourself and your passenger properly hydrated at all times so bring plenty of water and make it easily accessible.

Safety, comfort and well being are essential on every one of your runs; use common sense and pay close attention to your passenger's needs as well.

## BAD WEATHER CONDITIONS —

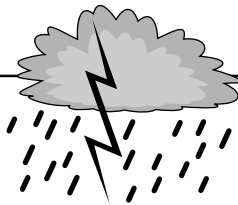

**Jogging in adverse weather conditions on roads that have become wet or slippery can be incredibly dangerous and should be avoided whenever possible. If you find yourself out in such conditions, use extreme caution because your ability to control and stop a stroller is greatly impaired.**

### *In wet, rainy or slick conditions observe the following safe handling procedures:*

- ▶ Your stopping distance will at least DOUBLE in wet or slippery conditions.
- ▶ At frequent intervals, lightly apply the hand brake to clear the wheel rim and brake pads of excess water buildup. Remember, in wet conditions it can take two full revolutions of a wheel just to clear away the water and begin to slow down.
- ▶ Never pull the brake lever forcefully or suddenly. *This could lock up the front wheel and cause dangerous, uncontrolled skidding.*
- ▶ Keep your speed to a minimum and allow for a greater margin of error when starting through intersections, stopping and cornering.
- ▶ Avoid riding over slick substances such as sand, loose gravel, ice, oil and other debris not intended as a strolling surface. These slick spots put a thin layer between you and the road, essentially removing your tires from the surface they are trying to hold. If slippery surfaces cannot be avoided it is advisable that you walk your stroller to reduce the risk of accidents and injury.



## **NEVER CARRY MORE THAN TWO PASSENGERS!**

This stroller is designed for two children. Do not attempt to carry more than two children. Do not allow a third child to climb into or on the stroller at any time.

# LOAD LIMITS

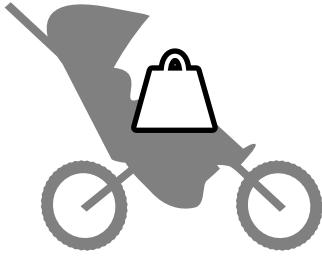

## **STROLLER WEIGHT LIMIT** **90 lbs. (41 kg)**

### **DO NOT EXCEED STROLLER WEIGHT LIMITS!**

- The maximum weight limit for child AND cargo is 90 lbs.
- Overloading may result in instability, decreased maneuverability and damage to the jogger.
- Maximum weight for backrest pocket is 3 lbs.
- Maximum weight for under seat cargo bag is 10 lbs.
- Use of backrest or underseat cargo bag may cause the stroller to be unstable.
- Excessive weight may cause a hazardous unstable condition.



### **WARNING**

**Exceeding this limit is unsafe and may result in accident or injury to passenger, stroller and jogger.**

### **BEFORE EACH RIDE, PROPERLY INFLATE YOUR TIRES!**

*Use only Yakima supplied wheels and keep them properly maintained in good, working order:*

- Check tires and inflate to recommended pressure.
- Do not use knobby, off-road tires. Use only road tires with street tread.
- Do not use tires wider than 1.75" (6.8 cm).
- Check for wear and proper inflation before each use.

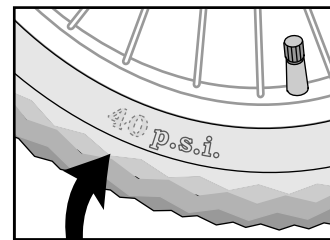

**Recommended  
air pressure  
is stated on  
the tire wall as  
"- - p.s.i."**



### **WARNING**

**Never use the stroller with improperly inflated tires!  
Failure to properly inflate your tires may lead to loss of control and serious injury or death!**

# SAFETY WARNINGS



## WARNING:

**Never leave children unattended while seated in the stroller.**

Never leave children UNBUCKLED—even for a moment—while seated in the stroller.

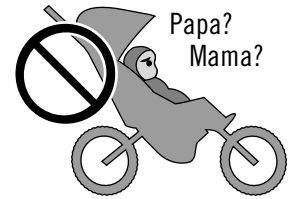

## NEVER STRAP BAGS OR PACKAGES TO STROLLER HANDLE.

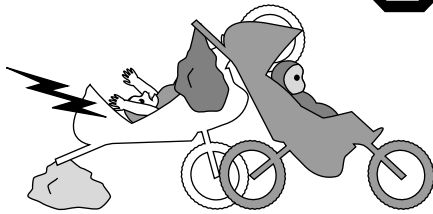

Extra weight on the handle will affect the balance and stability of the stroller and can cause it to tip over backwards.

### DO NOT OVERLOAD YOUR STROLLER!

Overloading will cause the stroller to tip over in the event of a sudden move or stop, causing injury or death to the passengers.



## WARNING:

**Failure to follow these warnings is unsafe and may result in injury or death to passengers.**

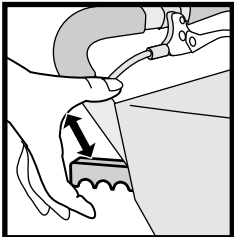

**Do not use the side fold-levers while a child is seated in the stroller.**



## WARNING:

**Do not use the side levers with a child in the stroller. The stroller may fold and cause serious injury to the child.**

## AVOID RADICAL TURNS!

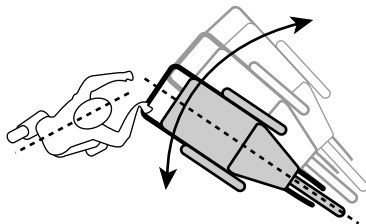

The danger of tipping over increases with greater speeds or downhill runs.

**Keep your hands on the bar at all times.**

Slow your pace, and carefully maneuver the stroller through turns.

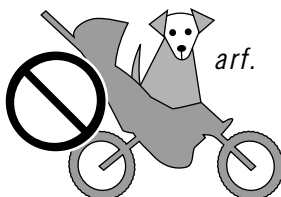
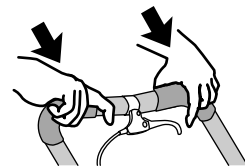

## TRANSPORTING ANIMALS

Yakima strollers are specifically designed to transport children, not your pets.

# 1 Read and understand the previous pages!



The following images may show a single passenger stroller. Follow the directions carefully for **BOTH** seats and for **EACH** passenger.

## 2 ASSEMBLE STROLLER:

Unpack and remove all wrapping from stroller and wheels.

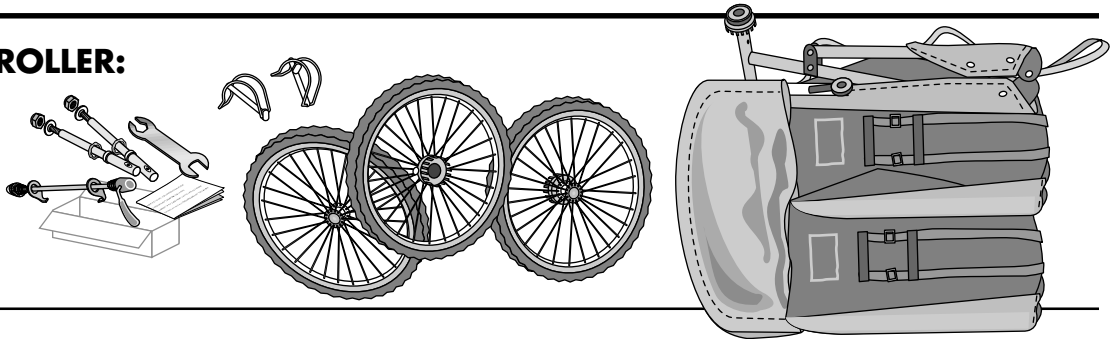

## 3 OPEN THE STROLLER —

1 Lift wheel forks out.

2 Extend seat outward.

3 Open frame until it snaps open and cannot fold closed.

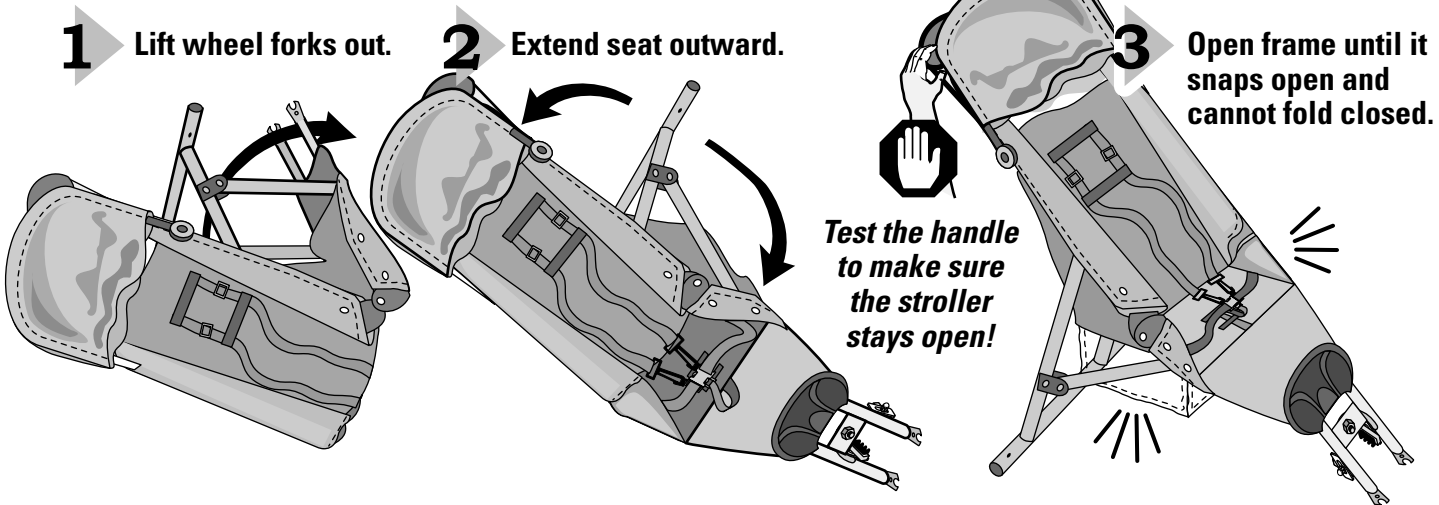

## 4 SECURE THE SEAT-TENSIONING STRAP.

- Buckle the strap around the frame if it is not buckled.
- Tighten completely.

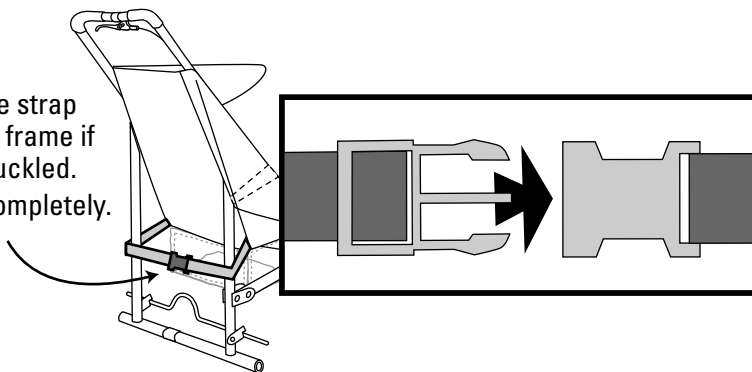

## 5 OPEN THE FOOT REST.

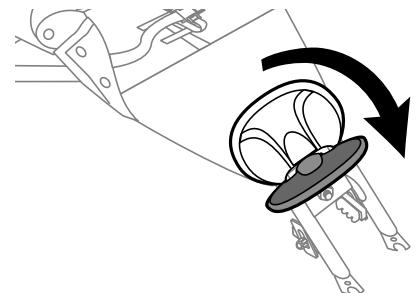

## PREPARE THE WHEELS...

### 6

First, check that all three tires are properly inflated to recommended air pressure. (Recommended air pressure is stated on the tire wall as "p.s.i.")

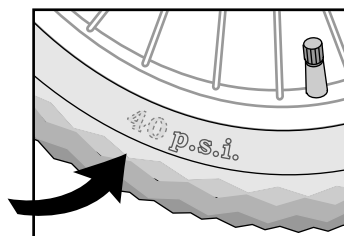

### WARNING:

Failure to properly inflate your tires may lead to loss of control of the stroller and serious injury or death!



# Assemble Axles on each Rear Wheel

**7**

## REMOVE NUT and FLAT WASHER.

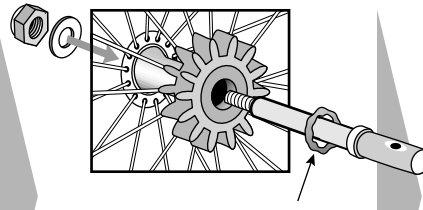
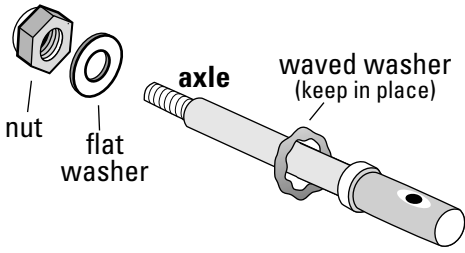

- Insert axle into wheel (waved washer must be in place).
- REATTACH NUT AND FLAT WASHER.

Use a small screwdriver to stabilize the axle while tightening the nut.

Tighten until the axle shows through the nut. The wheel should spin freely on the axle.

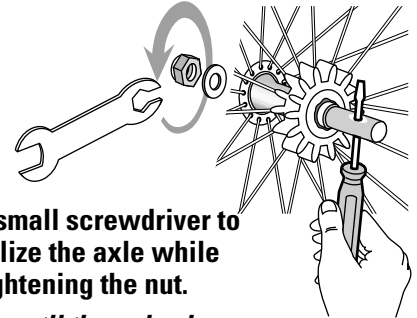

**8**

## INSTALL REAR WHEELS:

- Move brake bar up (if it is down).
- Insert axles into the axle frame.

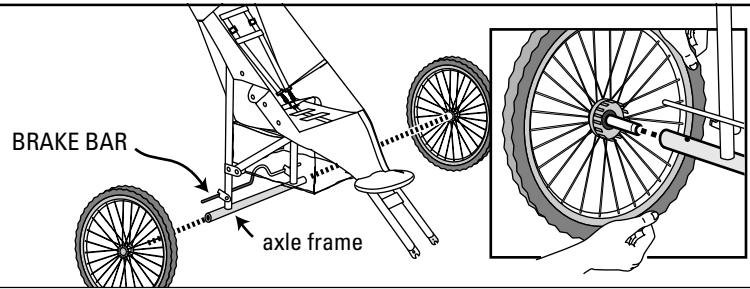

**9**

## SECURE THE AXLES WITH PINS!

While holding the nut in the wheel, rotate until the holes align.

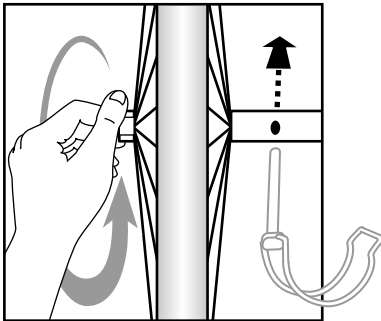

- Install the pins with the wire BELOW the axle.
- CLOSE BOTH wires over the ends of both pins.

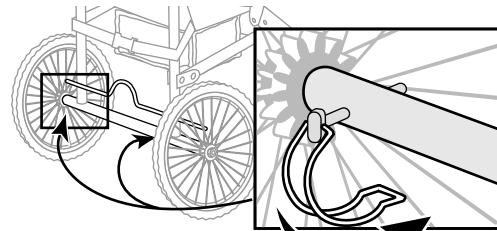

(REAR OF STROLLER)

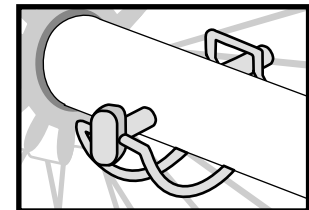

**10**



## TEST THE INSTALLATION.

Pull wheels outward to verify pin installation.

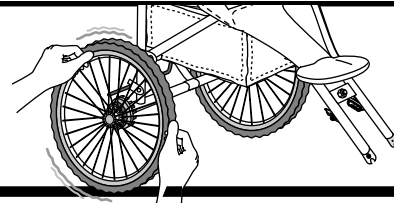

## FRONT WHEEL

**11**

## PREPARE SKEWER.

- Unscrew the nut from the skewer.

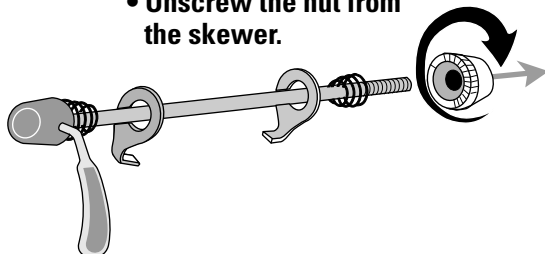

- Carefully remove the nut, and only the first spring and fork clip.

Remember the spring and clip position.

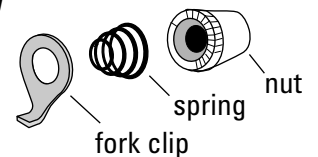

**12****Insert the skewer into the wheel.**

- Install the spring, small end first.
- Replace the clip.
- Replace the nut with a few turns—no more.

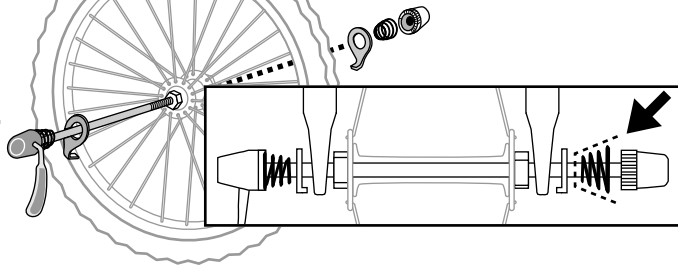

*Insert small end of spring first.*

**13****Attach front wheel.**

- Slide wheel between open brake pads.
- Insert forks onto skewer with quick release lever in the OPEN position.

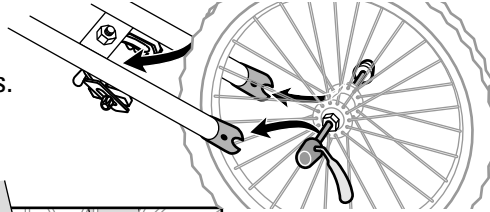
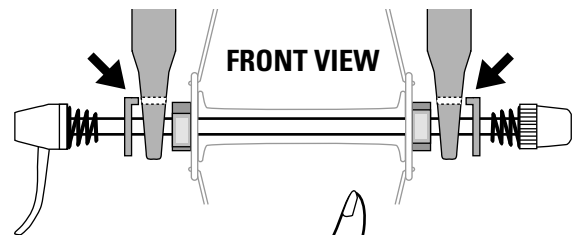
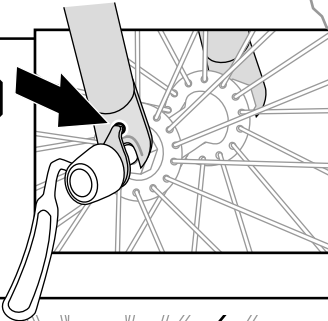
**14****Align the tabs on the fork clips to the holes in the fork dropouts.****15****Tighten and close the quick release lever.**

- Move lever to open position.
- Tighten the nut until the lever closes with FIRM resistance.

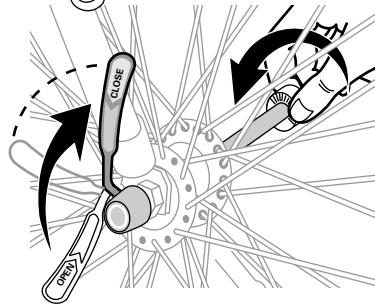
**CHECK THE WHEEL.**

The wheel is secure **ONLY** after the lever closes with solid resistance at halfway closed.

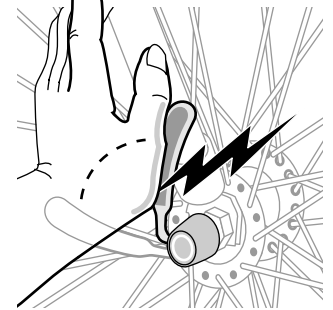
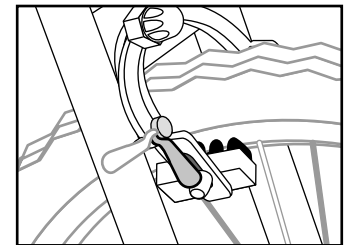
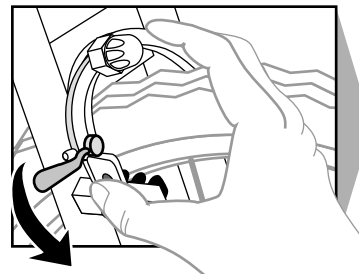
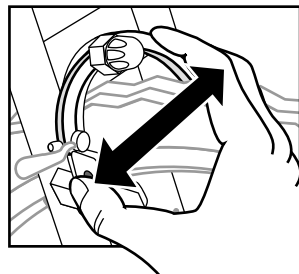
**16****ENGAGE THE BRAKE by compressing the calipers and closing the lever.****17****Adjust brake pads.**

- Adjust brake pads until aligned to metal rim of wheel.
- Do not allow the pads to contact the tire.
- The wheel must rotate freely without brake interference.

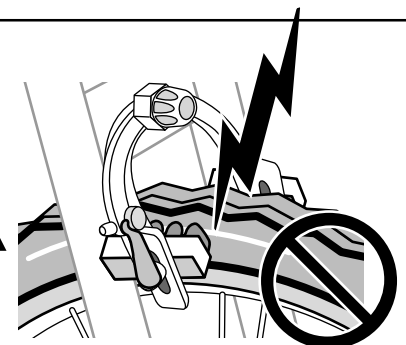
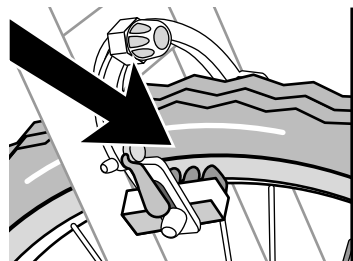
**WARNING:**

Brake pads will wear with use and need to be replaced regularly. Inspect and replace worn pads to reduce the risk of accident or injury.

**18****If the safety strap is not installed—**

Anchor the strap to the frame at the rear axle below the brake bar.

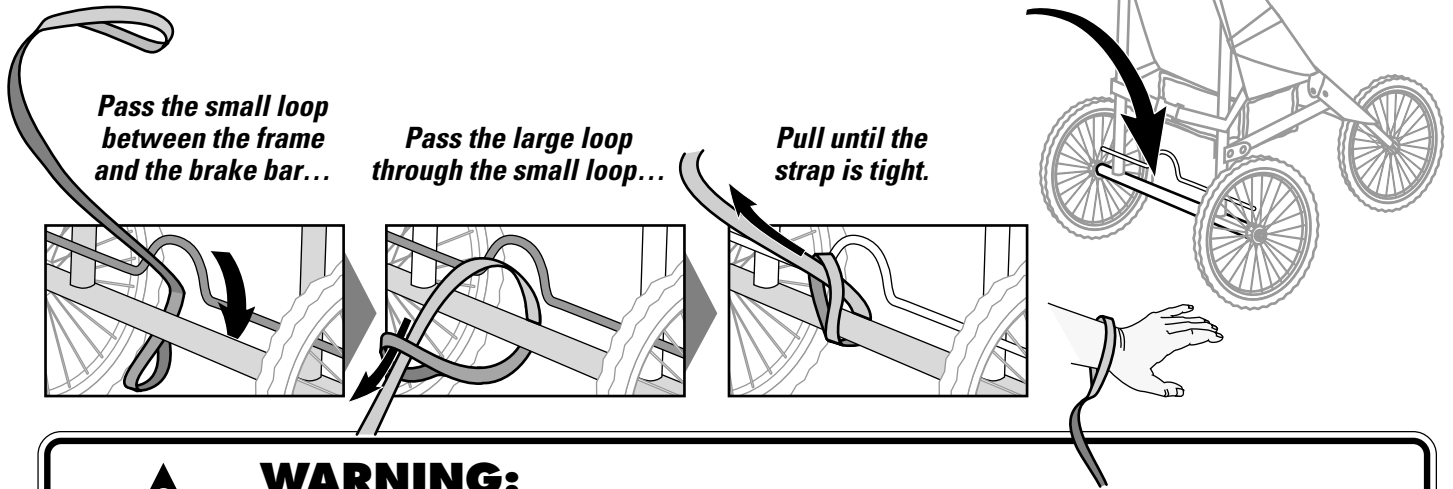
**WARNING:**

**The strap must be attached to the jogger's wrist at all times during stroller operation. Set the rear brakes when stopped. Failure to attach strap may cause jogger and stroller to become separated, resulting in serious injury or death.**

**19****ALWAYS SET THE BRAKE BEFORE LOADING YOUR CHILD.**

To set the rear brake, press down on the bar near the axle.

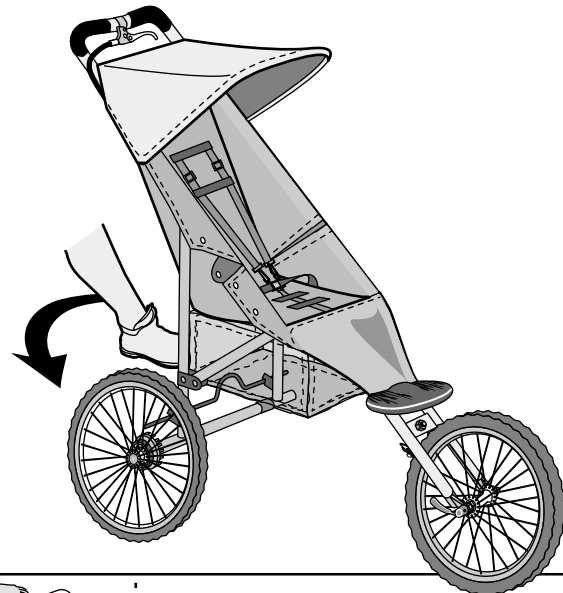
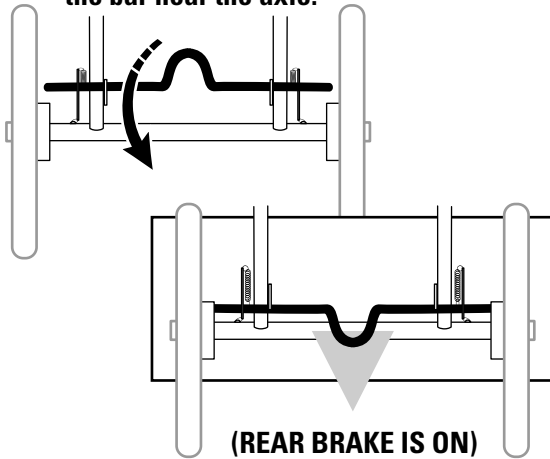
**20****TEST THE BRAKES.**

Grab the handle and try to roll the stroller.  
The rear wheels should not move.

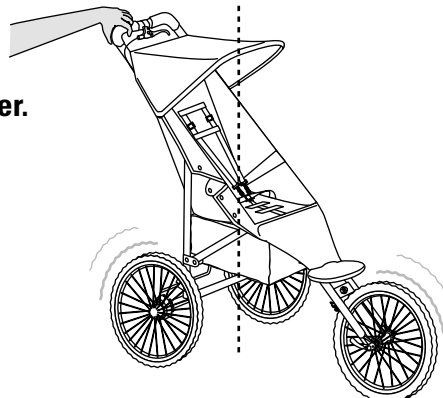

## TO QUALIFY AS A PASSENGER:

Child must be able to sit upright, and be strong enough to hold up his or her head.

If you are not sure, check with your pediatrician about your child's ability to support his or her head and sit alone while riding in a stroller.



## WARNING:

Avoid serious injury or death from child falling or sliding out: Always fasten seat belt/harness, and tighten all straps.

### 21 Open the straps and position your passenger.

- Attach the hooks.
- To engage the buckles, push the pieces together until you hear a click.

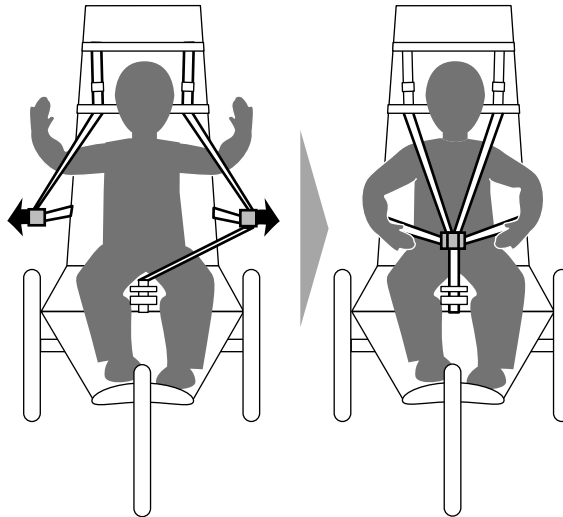
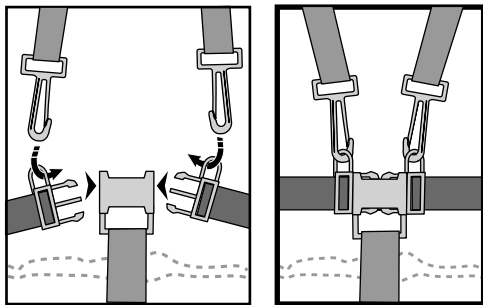

*Pull at the buckled straps to be sure straps are secured.*

*To engage the buckles, push the pieces together until you hear a click.*

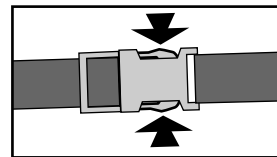
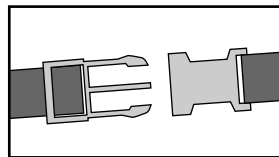

*To release the buckle, press the sides together.*

### 22 Adjust the crotch strap to fit your passenger.

Undo the strap to change the position.

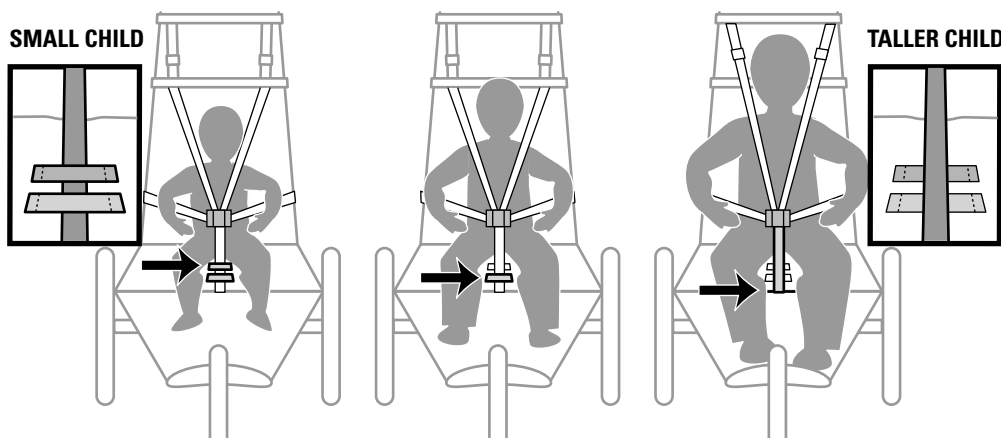

*Adjust length of crotch strap to fit the child.*

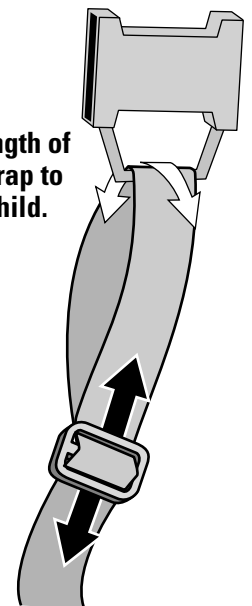

## 23 TIGHTEN SHOULDER STRAPS.

- Adjust the strap position to fit your child.
- Tighten the strap until the fit is firm.

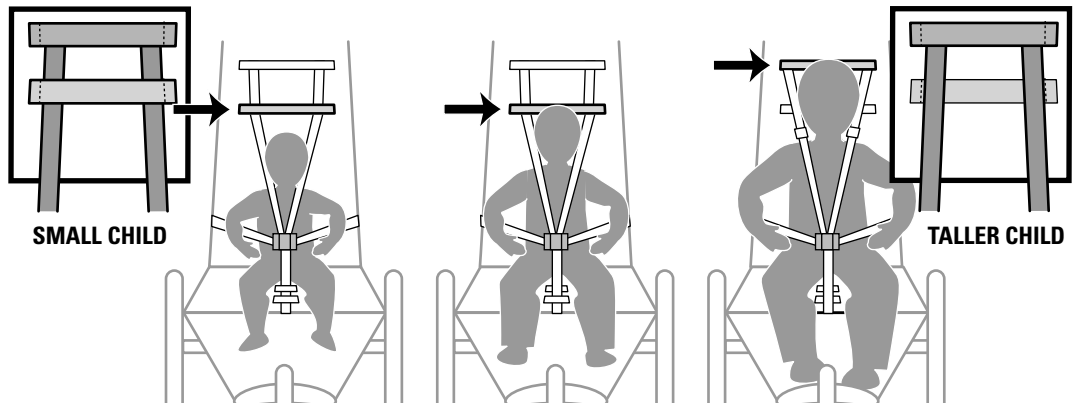

## 24 POSITION STRAP JUNCTION AT CHILD'S BELLY.

- Adjust by sliding the buckle in the crotch strap up or down depending on child's height.
- You may need to adjust the straps until the junction is positioned correctly.

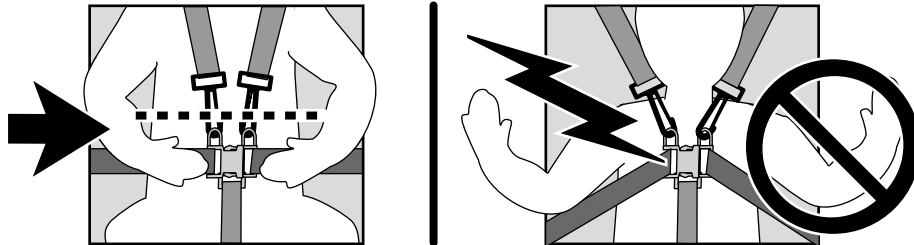

### WARNING

Straps which are too loose can allow the child to fall from the stroller. Potential choking hazard or neck injury can occur from a strap junction which is too high.

## 25 TIGHTEN ALL FIVE STRAPS.

Adjust the strap until the fit is firm.



*Pull at the buckled straps to be sure straps are secured.*

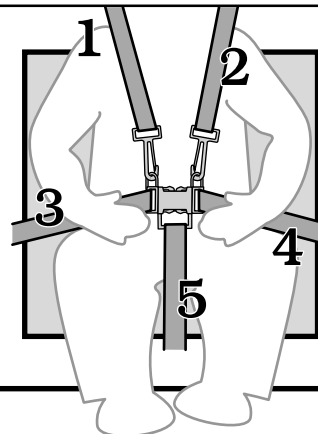

## 26 RELEASE THE BRAKES.

Lift brake bar to release the rear brakes.

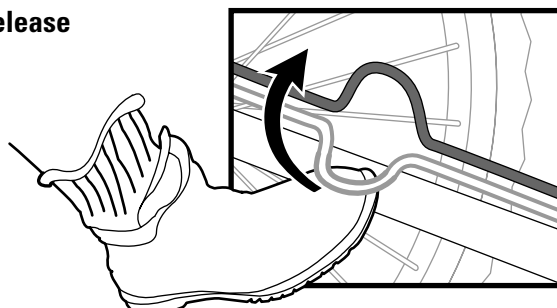

*Passenger must be secured before releasing the brakes!*



**BEFORE JOGGING, sit down with your passengers and make it clear that they may not bounce or rock from side to side. Shifting of weight from one side to another can cause tip over and must not be permitted.**

### **PASSENGER LOADING**

- Set the rear brakes to load or unload passengers.
- Lift children into stroller.
- Attach all straps and tighten securely.
- Junction of straps must be at child's belly. Belts or buckles near child's neck can cause discomfort or serious injury. Check child periodically.
- Never leave a child unattended.

### **BEFORE THE RIDE**

- Release the brakes by lifting up on the brake bar.
- Wrap the safety strap around your wrist.

### **DURING THE RIDE**

- DO NOT allow any of child's body, clothing, toys or other objects to come in contact with moving parts.
- CHILDREN must not rock, lean or bounce while sitting or riding in stroller.
- DO NOT allow children to play with buckles.

**27**



## **Absolutely-Must-Do BEFORE-YOU-JOG CHECKLIST**

- ✓ Tires must be properly inflated to recommended air pressure.
- ✓ Front wheel is installed correctly.
- ✓ Brake pads do not touch the tire—only the rim.
- ✓ Test front brakes by squeezing hand lever.
- ✓ Rear brakes engage properly.
- ✓ Load is within the limit of 90 lbs. (41 kg).
- ✓ Wrap the safety strap around your wrist when moving, or when brake is off.
- ✓ Passengers are securely strapped into stroller.
- ✓ Bolts and fasteners are intact, and there is no damage to the frame or fabric.
- ✓ An adequate supply of drinking water on board is recommended.
- ✓ No bags or packages are attached to the handle. Never place sharp or injurious objects into the seat's back rest pocket.



### **WARNING**

**Secure each child safely inside the stroller before moving! Failure to properly secure passengers may lead to serious injury or death! Avoid serious injury or death from a child falling or sliding out: Always fasten seat belts/harnesses, and tighten all straps.**

## FOLDING THE STROLLER

**28** Compress both side levers at the same time until handlebar can move downward.

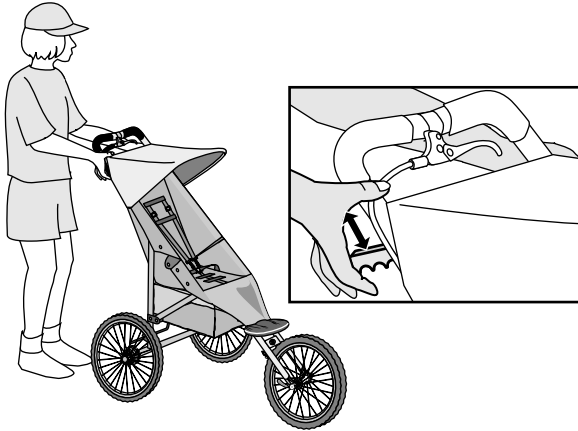

**! WARNING:**

Do not use the side levers with a child in the stroller. The stroller may fold and cause serious injury to the child.

**29** **FOLD:**  
Fold with wheels on...

...Or remove the wheels to save space.

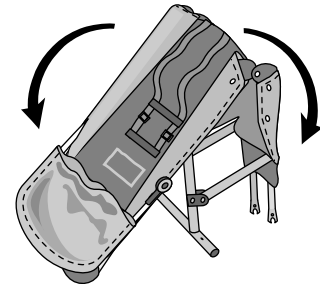
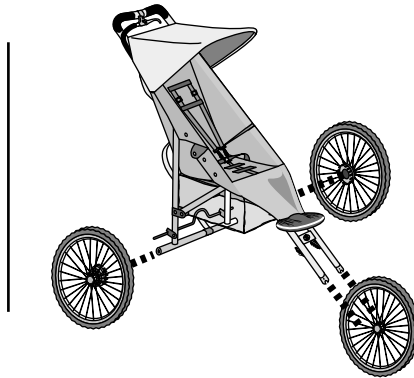
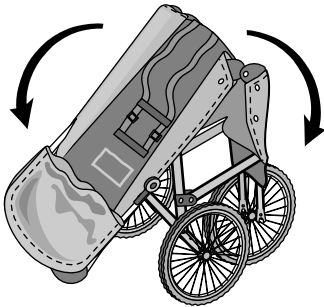

**30** FOLD THE FOOT REST.

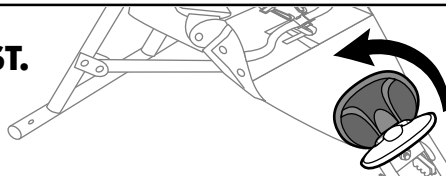

**31** **To remove wheels:**

### FRONT WHEEL:

- Free the brake pads by lifting the metal lever on the calipers.
- Loosen the skewer, remove the wheel.

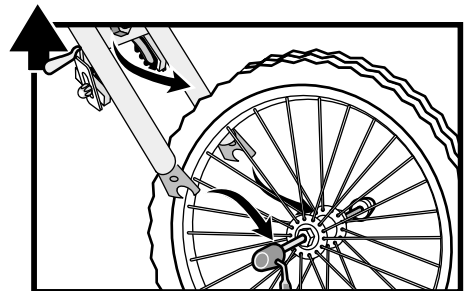
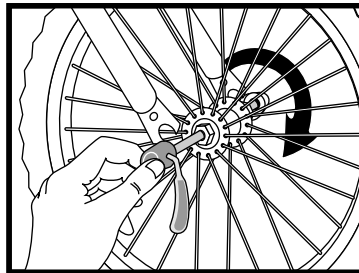

### REAR WHEELS:

- Push the axle spring-pin to free the axle from the frame.
- Release each wheel.

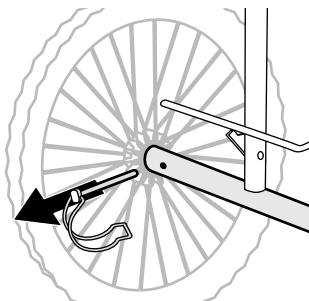
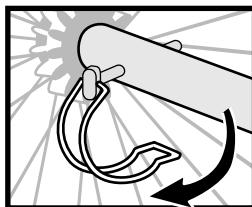

*The stroller needs to be well maintained for optimum safety. Perform regular maintenance and avoid travel hazards by addressing any malfunctions promptly. If you are uncomfortable completing any of these inspections, take your stroller to your local Yakima dealer for assistance.*

**— INSPECT STROLLER BEFORE EACH USE —**

- **INSPECT TIRES.** Cracked or worn tires can fail without warning and cause accidents.
- **INSPECT WHEEL** for trueness and spoke tension.
- **INSPECT WHEEL BEARINGS** for wear or excessive play.
- **INSPECT BRAKES** and replace when worn.

**CARE OF STROLLER FABRIC:**

Keep the stroller from extended periods of direct sunlight or exposure to weather. The stroller fabric can be cleaned with dishwashing soap and warm water. Allow the fabric to dry completely in a shaded area. Do not use bleach products or solvents.

***If You Lend Your Stroller —Send this Book Along Too!***

If you ever rent, loan, sell or swap your Yakima stroller, you must supply the designated user with this entire manual. Without exception, the



important information contained in this manual must be read and understood by anyone planning to use a Yakima stroller.

**IF YOU NEED FURTHER TECHNICAL ASSISTANCE OR REPLACEMENT PARTS:**  
Please contact your dealer or call us at (888) 925-4621 or (707) 826-8000, Monday through Friday, 8:00am to 5:00pm Pacific time.

**ATTACHMENT HARDWARE CAN LOOSEN OVER TIME. CHECK AND TIGHTEN IF NECESSARY, BEFORE EACH USE.**

**LIMITED WARRANTY**

Yakima Products ("Yakima") will repair or replace merchandise which proves defective in materials and/or workmanship. The limited warranty is effective for three years from the date of purchase. The limited warranty is applicable only if the Fit List (if applicable) and instructions are followed and the products are used properly. If a customer believes that a Yakima product is defective, the customer must return it to an authorized Yakima dealer with proof of purchase. Yakima will then issue authorization to the dealer for the return of these products. If an article is found to be defective upon inspection by Yakima, Yakima will repair or replace the defective article at its discretion without charge. The customer will pay freight to Yakima, and Yakima will pay any applicable return freight. Unauthorized returns will not be accepted. Normal wear and tear of Yakima products or damage resulting from misuse, accidents, or alterations are not covered by this Limited Warranty. The purchaser acknowledges that Yakima has no control over the attachment of its products to vehicles or the attachment of items to the Yakima products. Accordingly, Yakima cannot assume responsibility for any damage to any property arising out of the improper use of its products. In addition, this Limited Warranty applies only to Yakima products and not to other products used in conjunction with Yakima products. This Limited Warranty is in lieu of all other warranties, expressed or implied, and does not cover consequential damages of any kind that may arise from the use or misuse of any Yakima product.

**SAVE THESE INSTRUCTIONS!**